

JBL

**JBL CINEMA SOUND
SPEAKERS**

CS480

OWNER'S GUIDE



IMPORTANT SAFETY INSTRUCTIONS

1. Read these instructions.
2. Keep these instructions.
3. Heed all warnings.
4. Follow all instructions.
5. Do not use this apparatus near water.
6. Clean only with a dry cloth.
7. Do not block any ventilation openings. Install in accordance with the manufacturer's instructions.
8. Do not install near any heat sources such as radiators, heat registers, stoves or other apparatus (including amplifiers) that produce heat.
9. Do not defeat the safety purpose of the polarized or grounding-type plug. A polarized plug has two blades with one wider than the other. A grounding-type plug has two blades and a third grounding prong. The wide blade or the third prong is provided for your safety. If the provided plug does not fit into your outlet, consult an electrician for replacement of the obsolete outlet.
10. Protect the power cord from being walked on or pinched, particularly at plugs, convenience receptacles and the point where they exit from the apparatus.
11. Only use attachments/accessories specified by the manufacturer.
12. Use only with the cart, stand, tripod, bracket or table specified by the manufacturer or sold with the apparatus. When a cart is used, use caution when moving the cart/apparatus combination to avoid injury from tip-over.
13. Unplug this apparatus during lightning storms or when unused for long periods of time.



14. Refer all servicing to qualified service personnel. Servicing is required when the apparatus has been damaged in any way, such as power supply cord or plug is damaged, liquid has been spilled or objects have fallen into the apparatus, or the apparatus has been exposed to rain or moisture, does not operate normally or has been dropped.
15. Do not expose this apparatus to dripping or splashing and ensure that no objects filled with liquids, such as vases, are placed on the apparatus.
16. To completely disconnect this apparatus from the AC Mains, disconnect the power supply cord plug from the AC receptacle.
17. The mains plug of the power supply cord shall remain readily operable.
18. Do not expose batteries to excessive heat such as sunshine, fire or the like.



The lightning flash with arrowhead symbol, within an equilateral triangle, is intended to alert the user to the presence of uninsulated "dangerous voltage" within the product's enclosure that may be of sufficient magnitude to constitute a risk of electric shock to persons.



The exclamation point within an equilateral triangle is intended to alert the user to the presence of important operating and maintenance (servicing) instructions in the literature accompanying the product.
WARNING: To reduce the risk of fire or electric shock, do not expose this apparatus to rain or moisture.

THANK YOU FOR CHOOSING JBL

For more than 60 years, JBL has been involved in every aspect of music and film recording and reproduction, from live performances to the recordings you play in your home, car or office.

We're confident that the JBL system you have chosen will provide every note of enjoyment that you expected – and that when you think about purchasing additional audio equipment for your home, car or office, you will once again choose JBL.

Please take a moment to register your product on our Web site at www.jbl.com. It enables us to keep you posted on our latest advancements, and helps us to better understand our customers and build products that meet their needs and expectations.

INCLUDED

Carefully unpack the system. If you suspect damage from transit, report it immediately to your dealer and/or delivery service. Keep the shipping carton and packing materials for future use. Open the package and verify the following contents:

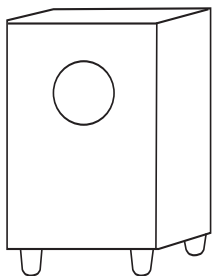

(1) Subwoofer

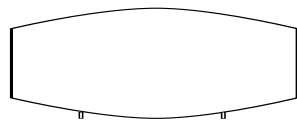

(1) Center with base

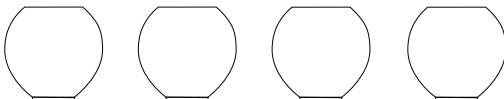

(4) Satellite speakers

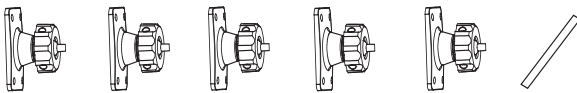

(5) Adjustable wall brackets for satellites and center channel with tightening bar

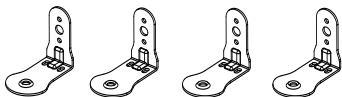

(4) Wall brackets for satellites



(1) Wall bracket for center channel

PLANNING YOUR SYSTEM

Before deciding where to best place your speakers, survey your room and study Figures 1 and 2.

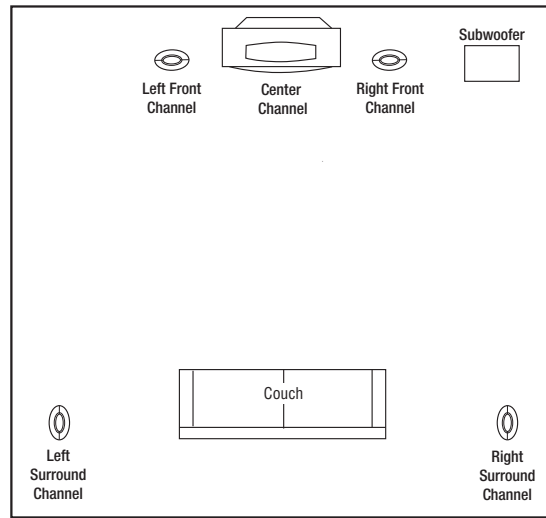

Figure 1. In this overhead view of a typical installation, satellite speakers are used to reproduce sound for the front and surround channels. The center channel reproduces sound and dialogue. The powered subwoofer provides bass for effects and music.

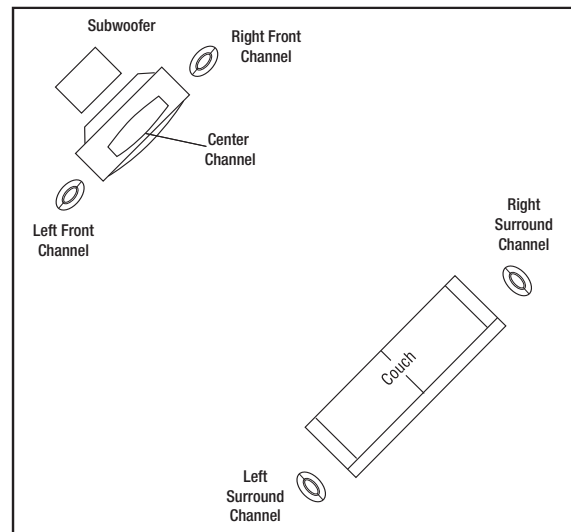

Figure 2. This figure shows an alternative layout, which may be more suitable for some rooms.

PLACEMENT

Left and Right Front Channels

For left and right front channels, place one satellite to the left and another to the right of the television, as shown in Figure 1. Since the speakers are magnetically shielded, you can place them very close to the TV without worrying about the magnetic field distorting the picture.

Center Channel

For the center channel, place the speaker directly on top of, or below, your television. Use a shelf or one of the included wall brackets if the television does not provide a stable platform.

Surround Channels

For left and right surround channels, place one speaker on the left and another on the right, to the side of or slightly behind the listening area. The surround speakers should be mounted at a height of between 5 ft. (1.5m) and 7 ft. (2m).

Subwoofer

Since the installation of a subwoofer can be somewhat more complicated than installing full-range speakers, it is essential that you read this section very carefully prior to connecting the subwoofer to your system. Should you have questions relating to installation, it is advisable to call either your dealer or JBL's Customer Service Department for advice.

The performance of the subwoofer is directly related to its placement in the listening room and how the subwoofer is aligned with the satellite speakers. Setting the volume of the subwoofer in relation to the left and right speakers is also of critical importance because it's essential that the subwoofer integrate smoothly with the entire system. Setting the subwoofer's volume level too high will result in an overpowering, boomy bass. Setting the volume level too low will negate the benefits of the subwoofer.

Here are several additional facts on installation that may prove useful. It is generally believed that low frequencies (below 125Hz) are nondirectional and, therefore, placement of a subwoofer within any listening room is not critical. While in theory it is true that the larger wavelengths of extremely low frequencies are basically nondirectional, the fact is that, when installing a subwoofer within the limited confines of a room, reflections, standing waves and absorptions generated within the room will strongly influence the performance of any subwoofer system. As a result, specific location of the subwoofer becomes important, and we strongly recommend that you experiment with placement before choosing a final location. Placement will depend upon your room (for example, whether or not your room permits placement of the subwoofer near either satellite) and the amount and quality of bass required.

WALL-MOUNTING THE SATELLITES AND CENTER CHANNEL

The CS480 satellites and center channel are designed to be mounted on the wall. There is a fixed-mount wall bracket and an adjustable wall bracket provided for each satellite and the center channel. Each speaker bracket will require up to four 1-1/2" #10 wood screws; each screw should be fastened to a wall stud. If a wall stud is unavailable, install an anchor appropriate for a 1-1/2" #10 screw.

NOTE: The customer is responsible for the correct selection and use of mounting hardware (available through hardware stores) that will ensure the proper and safe wall-mounting of the speakers.

Fixed-Mount Wall Bracket

Step 1. Mark the positions on the wall where you would like to place the mounting screws.

Step 2. Attach the bracket to the wall using two screws (not included).

Step 3. Remove the rubber ring on the bottom of the satellite and seat the satellite or center channel speaker onto the back bracket.

Step 4. Attach the 1/4-20 screw into the insert on the bottom of the speaker and tighten.

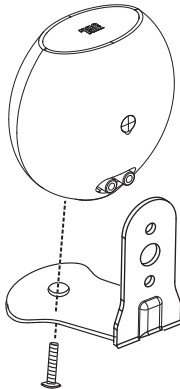

Adjustable Wall Bracket

Step 1. Remove the cap over the threaded insert on the rear of the speaker.

Step 2. Mark the positions on the wall where you would like to place the mounting screws.

Step 3. Place the bracket against the wall and fasten four 1-1/2" #10 wood screws (not included) through the bracket's screw holes into the wall. If a wall stud is not available, use an appropriate anchor.

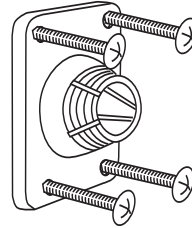

Step 4. Unscrew the round collar (C) from the bracket (A).

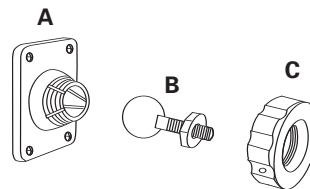

Step 5. Screw the ball and shaft assembly (B) to the 1/4"-20 insert on the back of the satellite or the center channel (do not use the bottom insert on either speaker). Back out 1/2 of a turn and tighten the nut against the speaker. If the ball and shaft assembly is not backed out before tightening the nut, performing Step 8 below may dislodge the threaded insert in the speaker housing and permanently damage the speaker.

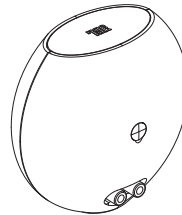

Step 6. Attach the speaker wire as shown on page 7.

Step 7. Drop the round collar (C) over the ball and shaft assembly (B) that is mounted to the speaker with the finished side of the collar facing the rear of the speaker.

Step 8. Carefully push the ball straight into the socket mounted on the wall, angle the speaker as desired and tighten the collar using the enclosed metal bar.

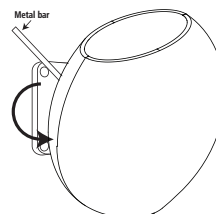

Figure 3. Bracket on wall.

CENTER AND SATELLITE SPEAKER CONNECTIONS

Turn Off All Power

After placing the speakers, you are ready to connect your system. First, turn off all audio-system power. Use high-quality speaker wire to make your connections (#18-gauge speaker wire with polarity coding is included). For longer distances, #16-gauge or heavier wire is recommended. The side of the wire with a ridge or other coding is usually considered positive (+) polarity. Also, consult the owner's manuals that were included with your amplifier or receiver to confirm connection procedures.

Satellites

Observe polarities when making speaker connections, as shown in Figure 4. Connect each + terminal on the back of the amplifier or receiver to the respective + (red) terminal on each speaker. Connect the – (black) terminals in the same way.

Important!

Do not reverse polarities (i.e., + to –, or – to +) when making connections. Doing so will cause poor imaging and diminished bass response. Be certain that positive and negative wire strands are completely isolated to avoid short circuits that may damage your equipment.

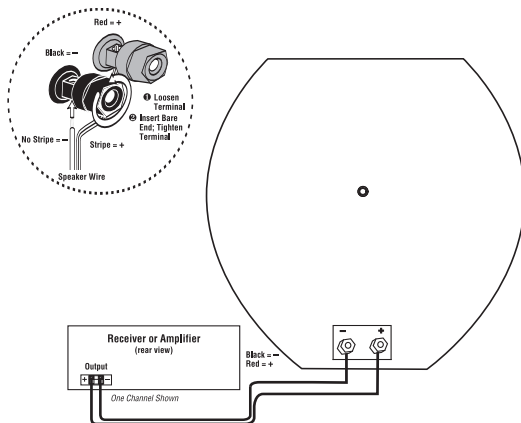

Figure 4. Wiring diagram shows polarity connections for one channel of a home theater system.

Center Channel

Observe polarities when making speaker connections, as shown in Figure 5. Connect each + terminal on the back of the amplifier or receiver to the respective + (red) terminal on the speaker. Connect the – (black) terminals in the same way.

Important!

Do not reverse polarities (i.e., + to –, or – to +) when making connections. Be certain that positive and negative wire strands are completely isolated to avoid short circuits that may damage your equipment.

NOTE: On certain models using hexagonal terminal nuts, a small socket wrench is provided to help in properly tightening the terminals. Hand-tighten only and do not overtighten.

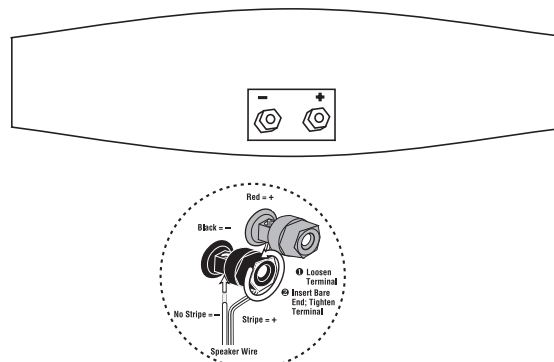
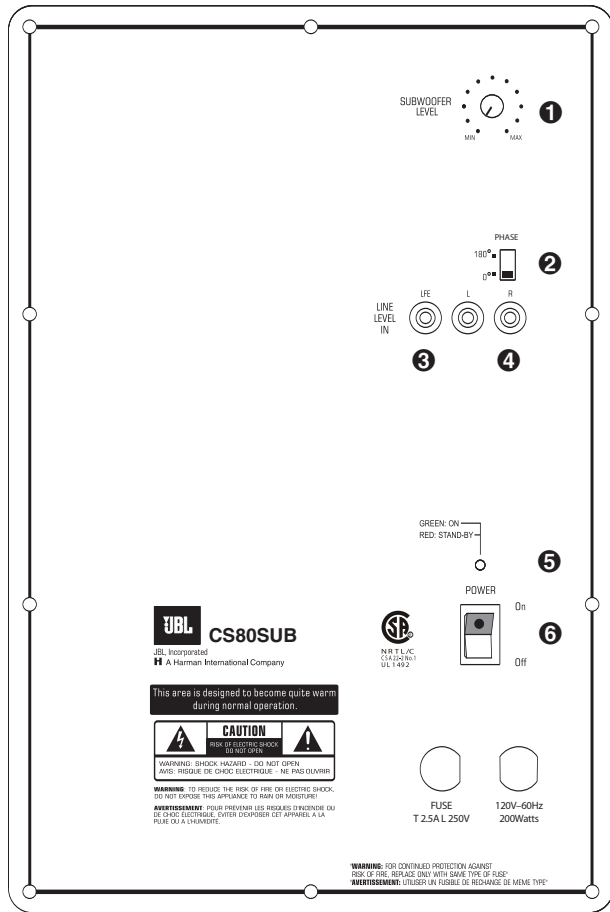

Figure 5. The satellites and center channel speaker feature terminals that can be connected in several different ways – e.g., spade terminals and direct wiring (as shown here).

SUBWOOFER CONTROLS

Rear Panel



- 1 Subwoofer-Level Control
- 2 Phase Switch
- 3 LFE Input
- 4 Line-Level Inputs
- 5 Power Indicator LED
- 6 Power Switch

Subwoofer Connections

If you have a Dolby® Digital or DTS® receiver/processor with a low-frequency-effects (LFE) or subwoofer output:

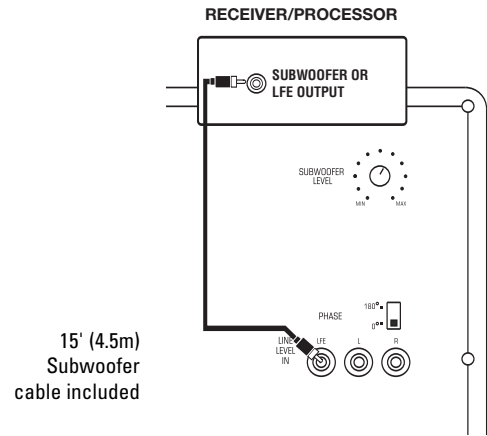

If your receiver/processor does not contain a Dolby Digital or DTS processor but has a subwoofer output:

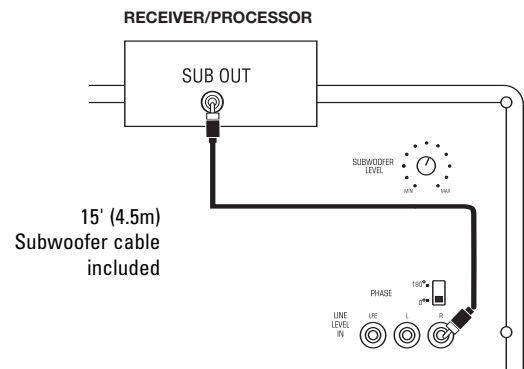

NOTE: If your receiver/processor has only one sub out, you may use either the L or R input.

Important!

Whenever changing cables, pulling plugs, etc., ALWAYS TURN OFF ALL EQUIPMENT, including the subwoofer.

OPERATION

Surround Modes

When using the CS480 in a Dolby Digital or DTS home theater system, make sure all speakers are set to "Small." In a Dolby Pro Logic® home theater system, make sure the receiver's center channel mode is set to "Normal."

Some Dolby Digital-equipped receivers/processors offer different setup options for each source or surround mode (e.g., CD-stereo, videotape, Dolby, Pro Logic). In each case, follow your equipment's instructions to ensure that the subwoofer output is turned on and that the speakers are set to "Small" in each mode.

Power On

Plug your subwoofer's AC cord into a wall outlet. Do not use the outlets on the back of the receiver.

Initially set the Subwoofer-Level Control ❶ to the "MIN" position.

Turn on the subwoofer by pressing the Power Switch ❷ on the rear panel.

Turn on your entire audio system and start a CD or movie soundtrack at a moderate level.

Auto On/Standby

With the Power Switch ❷ in the ON position, the LED on the rear panel ❸ will remain lit in green or red to indicate the ON or STANDBY mode of the subwoofer.

RED = STANDBY (No signal detected, Amp Off)

GREEN = ON (Signal detected, Amp On)

The subwoofer will automatically enter the Standby mode after approximately 10 minutes when no signal is detected from your system. The subwoofer will then power on instantly when a signal is detected. During periods of normal use, the Power Switch ❷ can be left on. You may turn off the Power Switch ❷ for extended periods of nonoperation, e.g., when you are away on vacation.

Adjust Level

Turn the Subwoofer-Level Control ❶ up about halfway. If no sound emanates from the subwoofer, check the AC-line cord and input cables. Are the connectors on the cables making proper contact? Is the AC plug connected to a "live" receptacle? Has the Power Switch ❷ been pressed to the ON position? Once you have confirmed that the subwoofer is active, proceed by playing a CD or DVD. Use a selection that has ample bass information.

Set the overall volume control of the receiver/processor to a comfortable level. Adjust the Subwoofer-Level Control ❶ until you obtain a pleasing blend of bass. Bass response should not overpower the room but rather be adjusted so there is a harmonious blend across the entire musical range. Many users have a tendency to set the subwoofer volume too loud, adhering to the belief that a subwoofer is there to produce lots of bass. This is not entirely true. A subwoofer is there to enhance bass, extending the response of the entire system so the bass can be felt as well as heard. However, overall balance must be maintained or the music will not sound natural. An experienced listener will set the volume of the subwoofer so its impact on bass response is always there but never obtrusive.

Phase Control

The Phase Switch ❸ determines whether the subwoofer speaker's pistonlike action moves in and out with the main speakers (0°) or opposite the main speakers (180°). Proper phase adjustment depends on several variables such as room size, subwoofer placement and listener position. Adjust the phase switch to maximize bass output at the listening position.

Final Positioning

After correctly connecting the CS480 system and verifying that both the subwoofer and all satellite speakers are playing, it is time to optimize the system for your particular listening room. Earlier, you placed the subwoofer in its general location. Finding the exact location for optimum performance sometimes only involves moving the speakers up to a few inches in any direction. We urge you, therefore, to experiment with placement, if possible, until your speakers deliver their full potential.

A Few Suggestions

We recommend that you do not operate your speakers or subwoofer with the bass, treble and loudness controls set to full boost. This will place undue strain on your electronics and speakers, and could damage them.

The volume control setting on your processor/preamp or receiver is not a specific indication of the overall loudness level of the speakers. The only important consideration is the loudness level at which the system can be played, regardless of where the volume control is set.

Always turn down the volume control setting on your processor/preamp or receiver when changing sources, or switching inputs to AM or FM operation. Excessively loud transients (clicks or popping sounds) can damage the satellite speakers and possibly the subwoofer.

Maintenance and Service

The satellite and subwoofer enclosures may be cleaned using a soft cloth to remove fingerprints or to wipe off dust.

All wiring connections should be inspected and cleaned or remade periodically. The frequency of maintenance depends on the metals involved in the connections, atmospheric conditions and other factors, but once per year is the minimum.

In the event that your system ever needs service, contact your local JBL dealer or distributor, or visit www.jbl.com for a service center near you.

SPECIFICATIONS

CS480

SATELLITES

Frequency Response (-6dB):	110Hz – 20kHz
Recommended Amplifier Power Range:	10 – 100 Watts
Sensitivity (2.83V @ 1 meter):	86dB
Nominal Impedance:	8 Ohms
Crossover Frequency:	3.0kHz; 12dB/octave
High-Frequency Driver:	1/2" (13mm) Titanium-laminate dome, magnetically shielded
Midrange Driver:	3-1/2" (89mm), magnetically shielded
Dimensions (H x W x D):	6" x 6-3/8" x 3-7/8" (152mm x 162mm x 98mm)
Weight:	2.0 lb (0.9kg)

CENTER

Frequency Response (-6dB):	100Hz – 20kHz
Recommended Amplifier Power Range:	10 – 100 Watts
Sensitivity (2.83V @ 1 meter):	88dB
Nominal Impedance:	8 Ohms
Crossover Frequency:	3.0kHz; 12dB/octave
High-Frequency Driver:	1/2" (13mm) Titanium-laminate dome, magnetically shielded
Midrange Driver:	Dual 3-1/2" (89mm), magnetically shielded
Dimensions (H x W x D):	5-1/4" x 11-3/8" x 3-3/8" (133mm x 289mm x 86mm)
Weight:	3.2 lb (1.5kg)

SUBWOOFER

Frequency Response (-6dB):	35Hz – 160Hz
Amplifier:	125W RMS/250W Peak†
Driver:	8" (200mm)
Dimensions (H x W x D, including feet):	16-1/4" x 12" x 13-5/8" (413mm x 305mm x 346mm)
Weight:	29 lb (13.2kg)

† The Peak Dynamic Power is measured by recording the highest center-to-peak voltage measured across the output of a resistive load equal to minimum impedance of the transducer, using a 50Hz sine wave burst, 3 cycles on, 17 cycles off.

All features and specifications are subject to change without notice.

JBL is a trademark of Harman International Industries, Incorporated, registered in the United States and/or other countries. Pro Sound Comes Home is a trademark of Harman International Industries, Incorporated.

Dolby and Pro Logic are registered trademarks of Dolby Laboratories.

DTS is a registered trademark of DTS, Inc.

JBL **PRO SOUND COMES HOME™**

Harman Consumer Group, Inc., 250 Crossways Park Drive, Woodbury, NY 11797 USA
8500 Balboa Boulevard, Northridge, CA 91329 USA
2, route de Tours, 72500 Château du Loir, France
516.255.4JBL (4525) (USA only) www.jbl.com
© 2007 Harman International Industries, Incorporated. All rights reserved.
Part No. 406-000-05538-E

H A Harman International Company